

**FOREMAN** Athletic Locker - Model: SCHOLARSHIP 80" High

INTERIOR VIEW  
WITHOUT DOOR

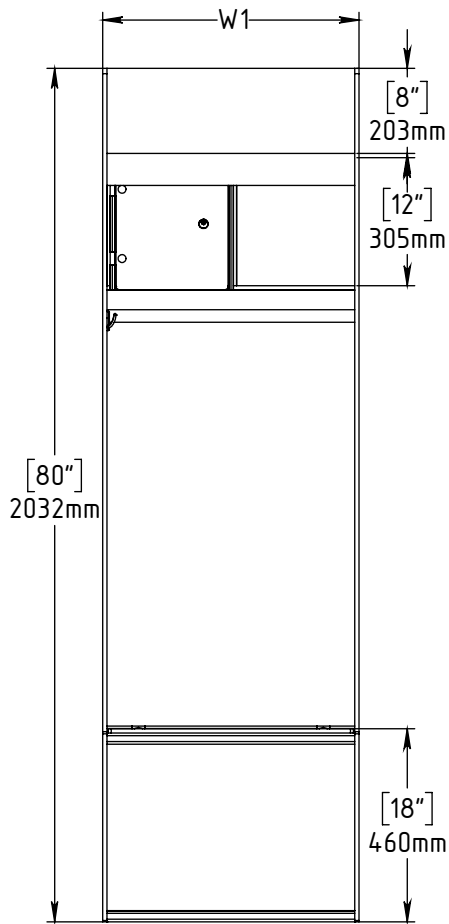

SIDE VIEW

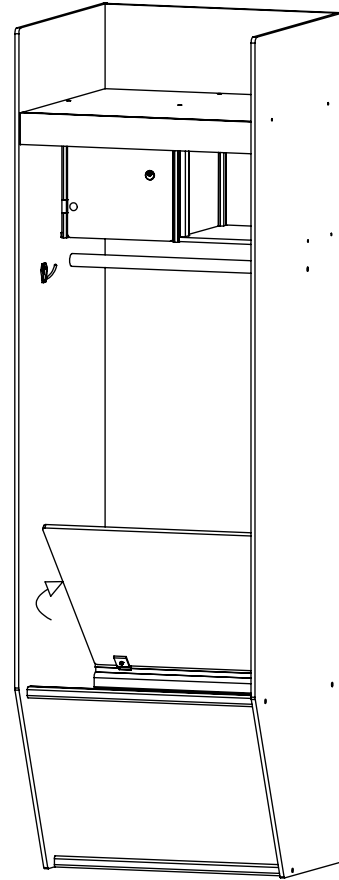
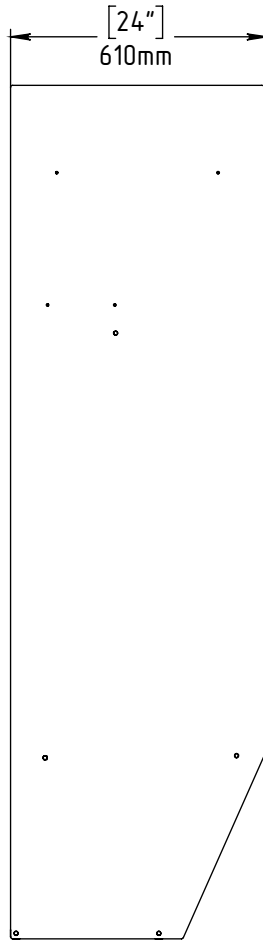

TOP VIEW

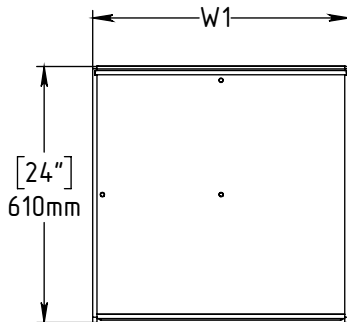

The model SCHOLARSHIP A480XX-SYZ is available in several widths with three different configurations for the upper and lower compartments.

XX = Width of the locker (Standard widths are 18", 24", 28", 30" and 32")

Y = Configuration of the upper compartment and can be substituted by:

"C" = Open Cubby

"S" = Split Compartment (Half-wide Lockable Safe and Half-wide Open Cubby).

Z = Configuration of the lower compartment and can be substituted by:

"L" = Full Size Locker with Lift-Up Lid

"C" = Open Cubby

**AVAILABLE WIDTHS**

OA Width (W1)	18"	24"	28"	30"	32"
		457mm	610mm	711mm	762mm



PROPRIETARY AND CONFIDENTIAL	DESCRIPTION	NAME	DATE
THE INFORMATION CONTAINED IN THIS DRAWING IS THE SOLE PROPERTY OF FOREMAN PRODUCTS LLC. ANY REPRODUCTION IN PART OR AS A WHOLE WITHOUT THE WRITTEN PERMISSION OF FOREMAN PRODUCTS LLC IS PROHIBITED	Athletic Locker - Model: SCHOLARSHIP 80" High	DRAWN BY	KB 01.01.2020
	--	MRG APPR.	NB --
	SCALE: --	Page 1 of 3	

**FOREMAN** Athletic Locker - Model: SCHOLARSHIP 80" High

Model: SCHOLARSHIP #A480XX-SCC  
Unit features an Upper Open Cubby and a Lower Open Cubby

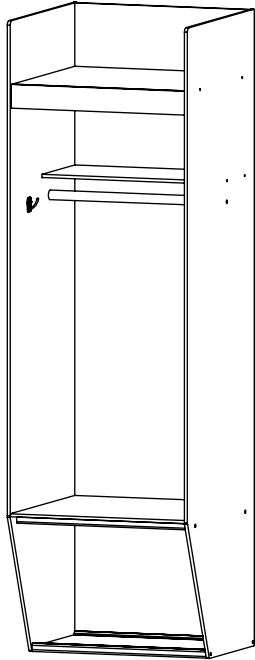

Model: SCHOLARSHIP #A480XX-SSC  
Unit features an Upper Safe and Small Cubby and a Lower Open Cubby

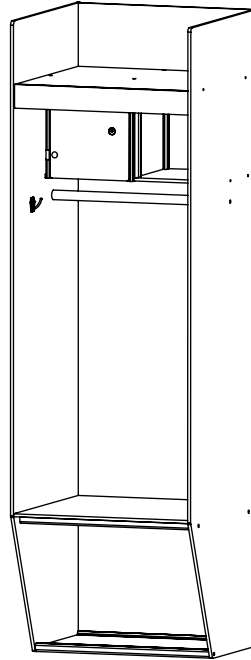

Model: SCHOLARSHIP #A480XX-SCL  
Unit features an Upper Open Cubby and a Lower Chest with Lift-up Seat

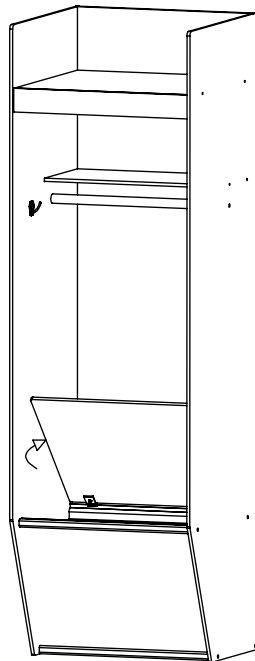

Model: SCHOLARSHIP #A480XX-SSL  
Unit features an Upper Safe and Small Cubby and a Lower Chest with Lift-up Seat

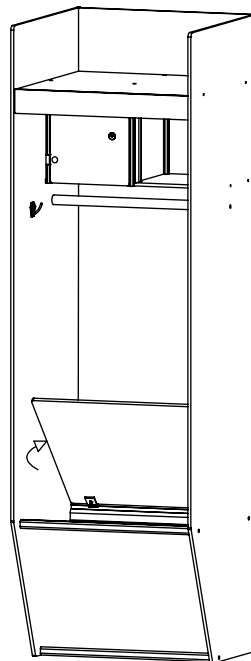

PROPRIETARY AND CONFIDENTIAL	DESCRIPTION	NAME	DATE
THE INFORMATION CONTAINED IN THIS DRAWING IS THE SOLE PROPERTY OF FOREMAN PRODUCTS LLC. ANY REPRODUCTION IN PART OR AS A WHOLE WITHOUT THE WRITTEN PERMISSION OF FOREMAN PRODUCTS LLC IS PROHIBITED	Athletic Locker - Model: SCHOLARSHIP 80" High	DRAWN BY	KB 01.01.2020
	--	MRG APPR.	NB --
	SCALE: --	Page 2 of 3	

**We incorporate the best materials and latest features** to meet modern requirements of the industry resulting in a bestselling product line. Our versatile construction design allows for a vast choice of sizes and configurations. The impressive "Musketeer Boot" shape of the FOREMAN<sup>®</sup> Athletic Lockers is a signature feature for optimal privacy and common usage of shared space. Our unique extruded aluminum profile allows us to utilize the material in a highly efficient manner. There is no need for excessively thick paneling. Our standard 3/8" (10mm) thick phenolic material secured with the aluminum aircraft quality profiles and stainless steel hardware has brought an extremely pricey product back down to an affordable level. Typically the lockers ship unassembled leading to significant savings for long distance shipping within the US or even worldwide. Assembling the Lockers does not require a professionally trained staff. The detailed installation manual and instructional video easily demonstrates how the locker are assembled. FOREMAN<sup>®</sup> lockers are constructed with Stainless Steel flush mounted bolts (Countersunk) so the lockers join together seamlessly.

### FEATURES:

FOREMAN<sup>®</sup> Athletic lockers are available in an 18", 24", 28" 30" or 32" width with a height of 72" or 80". We manufacture all types of athletic lockers for football, soccer, ice-hockey, basketball, and many other sports activities. Multiple compartments allow you to design your own sports locker. The smallest available compartment is 6" (155mm) x 7 1/2" (190mm) which is convenient for a cell phone or wallet. The biggest size of the opening is 32" (813mm) by 80" (2032mm). Currently there are (3) basic configurations of the upper compartment: open cubby, full size locker, or a spilt shelf with a safe and small cubby and (3) configurations for the lower compartment: open cubby, drawer, or a lockable chest with lid. We also offer an open space for an ice-hockey model.

### MODELS and CONFIGURATIONS

MODELS: Basic - Champion - Traditional - Scholarship  
MVP - Nord (Ice hockey Locker) - Tennis Locker.

SIZES: 18" - 32" width - 18"-28" depth - 72" or 80" high.

### INCLUDES:

- Modern HÄFELA Hardware
- Standard Aluminum Clothes Bar
- (2) Wall-Mounted Hooks (Hook Options Available).
- Hasps for Pad Lock (On lower compartment when the chest option is selected).
- Wide selection of colors by major HPL Manufacturers
- STOCK COLORS (For Faster Delivery) - White, Pastel Grey, Dark Grey Charcoal Grey, Black

- STOCK WOOD GRAIN COLORS: (For Faster Delivery) Tosca, Maple, Cello, Monte by FUNDERMAX<sup>®</sup>
- Two-Color Design (For face and side panel).
- Water Resistant - (The material withstands humid areas or direct water (valuable for installations near showers and cleaning).
- Large Selection of Lock Options
- Unique 20 Year Warranty

### OPTIONAL FEATURES

- Upholstered Seat Pad
- Debossed, Sewn or Imprinted Custom Logo on the Seat Pad
- Engraved and Acrylic Filled Custom Logo on Back Panel
- Gas Spring for a Soft Close Seat
- Customization: Our Company has 15 years of experience and state-of-the-art CNC machines that allows us to create your design based on your requirements. (About 50% of our products are designed by our customers).
- Custom colors for the Aluminum Profile
- Polycarbonate (or Tempered Glass) Doors - Great for Cheerleader Lockers.
- LED-light and USB Charger.
- Side-mounted Aluminum Channels for: Hard-Wired RFID-Locks or USB-charges (Conveniently located side-mounted versus back panel location).
- Thicker Material (1/2", 5/8" or 3/4") is available upon request to match the specification.

### CONSTRUCTION:

- Doors with Finished Radius Edges
- Aircraft Quality Aluminum Profiles with Integrated Hinges
- 3/8" or Optional 1/2" Solid Phenolic Doors and Shelves
- 3/8" Solid Phenolic Walls and Back Panels (Thicker material is available to meet specifications)
- Standard Aluminum Clothes bar
- 3M Brushed Aluminum Number Plate
- Name Plate
- Optional FOREMAN Hasp Lock

### APPLICATIONS:

- Sports Complexes
- Recreational Facilities
- Universities, Colleges and High Schools
- Fitness Centers
- Military Facilities
- Stadiums
- Training Facilities.