

DESIGNED FOR CHAMPIONS

Athletic locker systems



FOREMAN[®]
locker systems

foremanlockers.com



ABOUT US

FOREMAN® Locker Systems is known for innovative designs and state of the art locker construction. We bring that same design and engineering excellence to our comprehensive line of Athletic Lockers.

FOREMAN® Athletic Lockers can be found in the locker rooms of the NFL, NBA, NCAA as well as your local high school. There is a FOREMAN® Athletic locker to meet the needs of every athlete and sports venue.

Constructed from durable Phenolic Panels (HPL) and aircraft grade aluminum, our Athletic lockers are built to last. Every order is custom built to your specifications.

There are several standard sizes available to make it easy to integrate our lockers into your available space, 18, 20, 24, 28, 30, 32 and 36-inch widths are available.

Options include Team logos etched or imprinted on the locker back panels

and hundreds of colors and patterns by the leading phenolic manufacturers are available.

A premium Naugahyde® covered seat cushion can be added to provide a comfortable place for athletes to sit while changing.

All FOREMAN® Phenolic lockers come with a 20-Year limited warranty.

TABLE CONTENTS

Champion	4
Scholarship	6
Ice Hockey	8
Victory	10
Tennis	12
Cheerleader	14
Tradition	16
MVP	18
Trophy Corner Module	20
Benches	22
Specifications	24

CHAMPION



The FOREMAN® Champion fully featured Pro/Multi-Sport Athletic Locker is our most popular model.

The Champion features a Split Upper Shelf with a secure storage locker and a Half-size Open Cubby. A Lower Compartment with Tilt-up Seat is standard but a Spacious Drawer or an Open Cubby is also available. A name plate holder, clothes bar and two side HÄFELE hooks are also standard.

The 44" tall seating area can be customized with an upholstered cushion and a soft close mechanism. Our pad lock Hasp is standard for models with lockers but many lock options are available upon request.

The model comes in 18", 20", 24", 28" and 32" widths.

Model: CHAMPION

APPLICATIONS:

- Football
- Baseball
- Soccer
- Basketball
- Lacrosse
- Rugby

STANDARD SIZES:

- 18"W x 20"D x 80"H
- 20"W x 20"D x 80"H
- 24"W x 20"D x 80"H
- 28"W x 20"D x 80"H
- 32"W x 20"D x 80"H

FEATURES:

- 3/8" thick solid phenolic panels, Extruded Anodized Aluminum Profile with Integrated Hinges
- Clothes Bar
- 2 side hooks
- Lockable Upper Compartment
- 2 Designs of Upper Compartment (Split Shelf for a small Cubby and Lockable Safe compartment OR a full-size Cubby)
- Multiple Designs of Lower Compartments (Cubby, Drawer or a Chest)
- Name Plate Panel

OPTIONS:

- LED Lighting
- 110V Power / USB Outlet
- Gas Spring Assisted Seat
- Ventilation Screen
- Multi-Color Design
- Upholstered Seat Pad
- Team Logo

20 YEAR WARRANTY

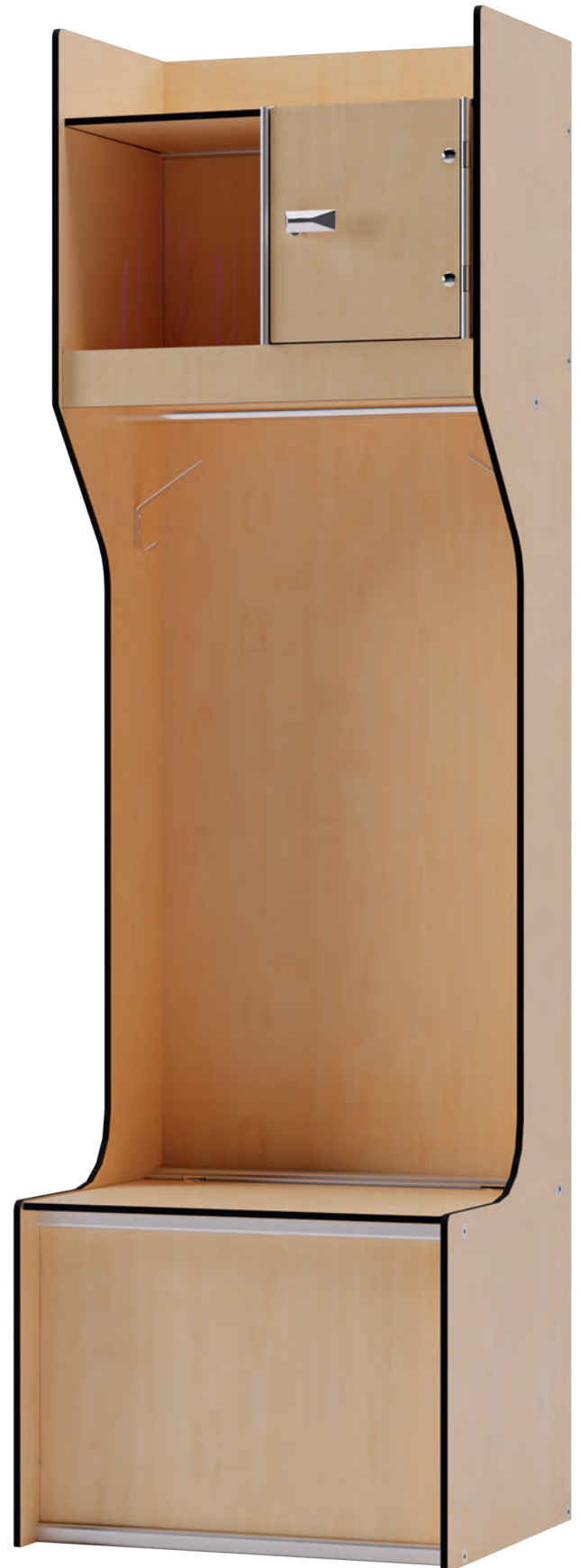



SCHOLARSHIP

The SCHOLARSHIP Football/ Baseball Athletic Locker is 80" Tall and features a large Upper Shelf, Safe Compartment, and a Small Cubby. The Open Upper Tray is perfect for Helmets or other bulky gear. The Spacious Lower Compartment has tilt up lid/seat that can be configured with a comfortable seat cushion.

The unique inclined lower front panel comes with a vent screen to promote air flow. The SCHOLARSHIP has a name plate holder, aluminum clothes bar and two standard side hooks

Standard widths are 24" and 28"

Model: SCHOLARSHIP

APPLICATIONS:

- Football
- Baseball
- Soccer
- Basketball
- Lacrosse
- Rugby

STANDARD SIZES:

- 24"W x 24"D x 80"H
- 28"W x 24"D x 80"H

FEATURES:

- 3/8" thick solid phenolic panels, Extruded Anodized Aluminum Profile with Integrated Hinges
- Clothes Bar
- 2 side hooks
- Lockable Upper Compartment
- 2 Designs of Upper Compartment (Split Shelf for a small Cubby and Lockable Safe compartment OR a full-size Cubby)
- Tilted Front Panel of the Lower Compartment for the comfort of an Athlete's feet
- Name Plate Panel

OPTIONS:

- LED Lighting
- 110V Power / USB Outlet
- Gas Spring Assisted Seat
- Ventilation Screen
- Multi-Color Design
- Upholstered Seat Pad
- Team Logo

20 YEAR WARRANTY



Designed for the special requirements of Hockey players, our state-of-the-art wide Ice Hockey locker has several unique features to accommodate protective gear. Extra wide lower compartment, inclined back support, inclined front panel to prevent damage by ice-hockey boots, spacious upper cubby and helmet tray on the top. We made the sitting area of a hockey player two extra inches higher due to the extra height of the blades.

Ventilation System
Our Hockey Locker is constructed for an optional built-in ventilation system that can be accessed from a door behind the seating area, this also can be used for an extra storage space when ventilation is not needed. Air flow comes from an internal channel created by the bank of Interconnected lockers, entering through the vent holes in the inner partition, and out through the vent screen of the front panel.

Width: 36" and 42" extra wide
Goalie locker

ICE HOCKEY



Model: ICE HOCKEY

APPLICATIONS:

- Professional Ice Hockey

STANDARD SIZES:

- 36"W x 24"/28"D x 80"H
- 42"W x 24"/28"D x 80"H

FEATURES:

- 3/8" thick solid phenolic panels, Extruded Anodized Aluminum Profile with Integrated Hinges
- 4 two-prong hooks
- Spacious Lockable Lower Compartment with an optional Enforced or traditional electric Ventilation System
- Tilted Front Panel of the Lower Compartment for the comfort of an Athlete's feet
- Name Plate Panel
- Standard Gas Spring Assisted Seat Lid

OPTIONS:

- LED Lighting
- 110V Power / USB Outlet
- Gas Spring Assisted Seat
- Ventilation Screen / Enforced Ventilation System
- Small Lockable Upper Compartment or a safe
- Multi-Color Design
- Upholstered Seat Pad
- Team Logo

20 YEAR WARRANTY

VICTORY



The VICTORY Athletic locker is a very versatile design made for multi-sport locker rooms. Several widths and three upper and lower compartment configurations are available.

Standard Widths of 18", 20", 24", 28" and 32" are available.

Upper Compartment Configurations:

- Full Size Locker with Vertical Lift-Up Door
- Open Cubby
- Split Compartment (Half-wide Lockable Storage and Half-wide Open Cubby)

Lower Compartment Configurations:

- Full Size Locker with Lift-Up Lid
- Drawer
- Open Cubby

Model: VICTORY

APPLICATIONS:

- High School and University Sport complexes
- Volleyball
- Basketball
- Baseball
- Multiple kinds of sports

STANDARD SIZES:

- 18"W x 20" x 71"H
- 20"W x 20" x 71"H
- 24"W x 20" x 71"H
- 28"W x 20" x 71"H
- 32"W x 20" x 71"H

FEATURES:

- 3/8" thick solid phenolic panels, Extruded Anodized Aluminum Profile with Integrated Hinges
- Clothes Bar
- 2 two-prong hooks
- 3 configurations of Upper Compartment
- 3 configurations of Lower Compartment

OPTIONS:

- LED Lighting
- 110V Power / USB Outlet
- Soft-Close Upper Door (for Full-size Upper Locker with vertical opening)
- Gas Spring Assisted Seat
- Name Plate Panel
- Small Lockable Upper Compartment or a safe
- Multi-Color Design
- Upholstered Seat Pad
- Team Logo

**20 YEAR WARRANTY**



Our Racquet Club Inspired Tennis Locker is designed with two large personal storage lockers and large upper and lower compartments. Each locker has two three-prong rotating clothes hook and a shelf for holding valuables. The Upper and Lower compartments are perfect for duffel bags.

TENNIS

Model: TENNIS

APPLICATIONS:

- Tennis
- Racquetball
- Squash

STANDARD SIZES:

- 30"W x 20"D x 71"H

FEATURES:

- 3/8" thick solid phenolic panels, Extruded Anodized Aluminum Profile with Integrated Hinges
- Clothes Bar
- 2 two-prong hooks in each compartment
- 180-degree door opening
- Inner shelf for personal valuables

OPTIONS:

- LED Lighting
- 110V Power / USB Outlet
- Imprinted Pictures on Doors
- Custom color of profiles

20 YEAR WARRANTY



CHEERLEADER



Our Spacious and stylish Cheerleader locker features a vanity shelf, tall garment locker with a lockable inner safe compartment and an overhead storage compartment with a gas spring assisted door. Power outlets with USB connections are standard. Options include an upholstered stool and a lighted variable intensity mirror.

Available in many Solid Colors and Wood Grains.

Model: CHEERLEADER

APPLICATIONS:

- Cheerleader
- Circus
- Theater

STANDARD SIZES:

- 40"W x 20"D x 71"H
- 40"W x 20"D x 80"H

FEATURES:

- 3/8" thick solid phenolic panels, Extruded Anodized Aluminum Profile
- Clothes Bar
- Three-prong rotating hook
- Inner shelf for personal valuables
- 110V / USB outlet
- Mirror
- Stool with Upholstered Seat Pad

OPTIONS:

- LED Lighting
- Backlit mirror
- Inner Safe Compartment
- Imprinted Pictures / Photos on Doors
- Two-Color Design

20 YEAR WARRANTY

TRADITION



The very first FOREMAN Athletic Locker designed in 2016.

The TRADITION is a true classic, it has a full-size upper compartment with a gas spring assisted door and a Lockable Lower Compartment with a Seat/Lid, a Drawer is an option.

Upper Compartment may have a split design for a safe locker and a small cubby or full-size cubby design.

Model: TRADITION

APPLICATIONS:

- Football
- Baseball
- Soccer
- Basketball
- Lacrosse
- Rugby

STANDARD SIZES:

- 18"W x 20" x 80"H
- 20"W x 20" x 80"H
- 24"W x 20" x 80"H
- 28"W x 20" x 80"H
- 32"W x 20" x 80"H

FEATURES:

- 3/8" thick solid phenolic panels, Extruded Anodized Aluminum Profile with Integrated Hinges
- Clothes Bar
- 2 side hooks
- Name Plate Panel
- Extra Open Shelf
- 3 configurations of Upper Compartment
- 3 configurations of Lower Compartment

OPTIONS:

- LED Lighting
- 110V Power / USB Outlet
- Soft-Close Upper Door (for Full-size Upper Locker with vertical opening)
- Gas Spring Assisted Seat
- Name Plate Panel
- Small Lockable Upper Compartment or a safe
- Multi-Color Design
- Upholstered Seat Pad
- Team Logo

20 YEAR WARRANTY

MVP



The MVP Athletic locker is engineered for the organization that needs high quality, waterproof storage for athletes at a reduced cost.

Made from Phenolic panels and Aircraft Quality Aluminum Profiles the MVP's unique design reduces locker cost and allows us to ship the lockers both assembled and knocked down for easy assembly on site.

MVP lockers come in 60" or 71" heights with two lockable compartments, a standard clothes bar and two side hooks.

The MVP is a Perfect solution for College, High schools, and University sports programs.

Model: MVP

APPLICATIONS:

- Football
- Baseball
- Soccer
- Basketball
- Lacrosse
- Rugby

STANDARD SIZES:

- 18"W x 20" x 60"/71"H
- 20"W x 20" x 60"/71"H
- 24"W x 20" x 60"/71"H

FEATURES:

- 3/8" thick solid phenolic panels, 1/8" thick solid phenolic Back and Side panels, Extruded Anodized Aluminum Profile with Integrated Hinges
- Clothes Bar
- 2 side hooks
- 2 configurations of Upper Compartment

OPTIONS:

- LED Lighting
- 110V Power / USB Outlet
- Gas Spring Assisted Seat
- Custom Colored aluminum Profile
- Upholstered Seat Pad
- Team Logo

20 YEAR WARRANTY

TROPHY CORNER MODULE



Our Corner Trophy locker acts as a connecting module for the Majority of our Athletic Locker line, or as a standalone functional locker.

TCM has a lockable lower compartment, spacious upper cubby and shelf convenient for a TV or a trophy display.

Model: TROPHY CORNER

APPLICATIONS:

- Football
- Baseball
- Soccer
- Basketball
- Lacrosse
- Rugby

STANDARD SIZES:

- 32"W x 32" x 71"/80"H
- 40"W x 40" x 71"/80"H

FEATURES:

- Material: 3/8" thick solid phenolic panels, Extruded Anodized Aluminum Profile
- Spacious lockable lower compartment
- Customized Shelving

OPTIONS:

- LED Lighting
- 110V Power / USB Outlet
- Team Logo

20 YEAR WARRANTY



BENCHES



FLOOR-MOUNTED BENCH

Our sturdy and very durable benches are made with a 5/8" phenolic top with finished radius edges and stainless-steel posts. Available in multiple sizes and colors. An ADA bench is also available. The ADA bench has 4 stainless steel posts and can be used as a free-standing bench or installed against the wall.



BENCH WITH HANGERS AND BACK SUPPORT

Our double-sided bench is designed for locker rooms with limited seating. The bench features an integrated back support with clothes hooks. Constructed from 5/8" thick side panels and aluminum aircraft quality aluminum. The bench has convenient shoe shelves beneath the seat.

An upholstered seat cushion is an option.



FREE STANDING BENCH

Based on our Signature line of lockers, our Free Standing bench is extremely stable, made from 1/2" thick phenolic side panels and aircraft quality aluminum supports. The bench features a convenient integrated shoe shelf. An optional upholstered seat pad is available.

Available in multiple sizes and colors.

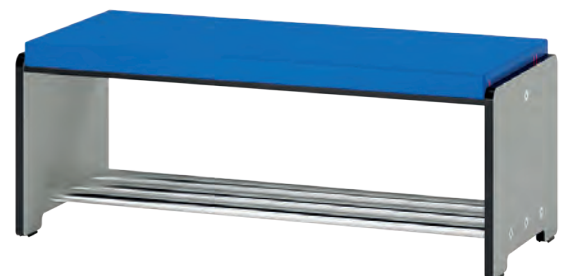

SPECIFICATIONS

FOREMAN consults with Players and Sports Industry Design Professionals when designing our products. For Engineering Drawings and BIM files please visit foremanlockers.com or contact our sales team for expert advice on products and planning of your next locker room project.

FOREMAN STANDARD AND OPTIONAL FEATURES:



Optional LED Light



Soft-close upper door



Soft-close seat lid door



Aluminum Hooks and Clothes Bar



USB/110V Outlet



Custom Club Logo



Upholstered Seat Pad



Multi-Color Option



Ventilation Screen



Safe Compartment with keypad lock



Backlit Mirror

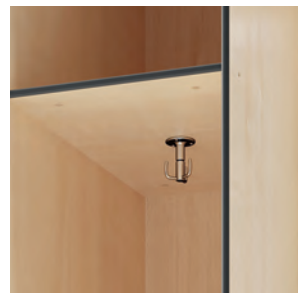

3-prong HÄFELE rotating hook



Pad lock

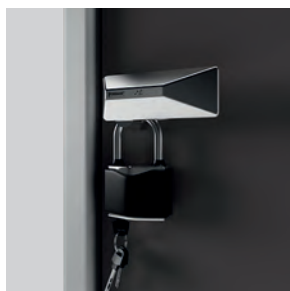

FOREMAN Hasp

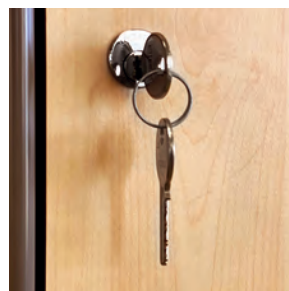









Key lock





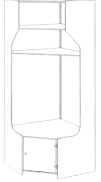

Combination Lock

DIMENSIONS, FEATURES AND OPTIONS



				
	Champion	Scholarship	Ice Hockey	Victory
Overall Height	80"	80"	80"	71"
Width	18"/ 20"/ 24"/ 28"/ 32"	24"/ 28"	24"/ 28"/ 32"/ 36"	18"/ 20"/ 24"/ 28"/ 32"
Overall Depth	20"	20" / 24"	24"/ 28"	20"
Upper Comp. Height	12"	12"	8"/12"	7 1/2"
Upper Comp. Depth	14"	18"	16"	14"
Lower Comp. Height	18"	18"	20"	18"
Seating Area Height / with pad	44"/ 45"	42"/43"	44"/45"	43"/ 44"
LED Lighting	optional	optional	optional	optional
Power Outlet / USB	optional	optional	optional	optional
Backlit Mirror	–	–	–	–
Soft-Close Upper Door	N/A	N/A	N/A	optional
Gas Spring Assisted Seat	optional	optional	STD	optional
Clothes Bar	STD	STD	optional	STD
Hooks, Qty	2 side hooks	2 side hooks	2 side & 2 back hooks	2 side hooks
Lockable Upper Compartment	optional	optional	optional	optional
Multiple Types of Upper Comp.	√	√	√	√
Multiple Types of Lower Comp.	√	N/A	N/A	√
Ventilation Screen	optional	optional	STD	optional
Multi-Color Option	optional	optional	optional	optional
Upholstered Seat Pad	optional	optional	optional	optional
Team Logo	optional	optional	optional	optional
Name Plate Panel	STD	STD	optional	optional
Construction / Material	3/8" thick solid phenolic panels, Extruded Anodized Aluminum Profile with Integrated Hinges	3/8" thick solid phenolic panels, Extruded Anodized Aluminum Profile with Integrated Hinges	3/8" thick solid phenolic panels, Extruded Anodized Aluminum Profile with Integrated Hinges	3/8" thick solid phenolic panels, Extruded Anodized Aluminum Profile with Integrated Hinges
Warranty	20 Y	20 Y	20 Y	20 Y

				
Tennis	Cheerleader	Tradition	MVP	Corner
71"	71" / 80"	80"	60" / 71"	71" / 80"
30"	40"	18" / 20" / 24" / 28" / 32"	18" / 20" / 24"	32" / 40"
20"	20"	20"	20"	18" / 20"
16"	- / 8"	13"	8" / 12"	12"
20"	16"	14"	18"	32" / 40"
16"	71" (locker)	18"	14" / 18"	18"
38" (locker)	42" (mirror) / 30"	44" / 45"	38" / 40"	44" / 45"
optional	optional	optional	N/A	optional
optional	STD	optional	N/A	optional
-	optional	-	-	-
N/A	- / STD	optional	N/A	N/A
N/A	N/A	optional	optional	N/A
optional	STD	STD	STD	N/A
2 x 3-prong rotating hooks	1 x 3-prong rotating hook	2 side hooks	2 side hooks	optional
N/A	optional	optional	optional	N/A
N/A	N/A	√	√	N/A
N/A	N/A	√	N/A	N/A
N/A	N/A	N/A	N/A	√
optional	optional	optional	Powder coated frame	optional
N/A	STD (stool)	optional	optional	optional
N/A	optional	optional	optional	N/A
N/A	optional	optional	optional	N/A
3/8" thick solid phenolic panels, 1/8" thick side and back Panels, Extruded Anodized Aluminum Profile with Integrated Hinges	3/8" thick solid phenolic panels, Aluminum Extruded Anodized Profile with Integrated Hinges	3/8" thick solid phenolic panels, Aluminum Extruded Anodized Profile with Integrated Hinges	3/8" thick solid phenolic panels, 1/8" thick side and back Panels, Extruded Anodized Aluminum Profile with Integrated Hinges	3/8" thick solid phenolic panels, Aluminum Extruded Anodized Profile
20 Y	20 Y	20 Y	20 Y	20 Y



BENCHES

		Width	Depth	Height
	Single Bench on Stainless Steel Posts, Floor Mounted	36" / 48" / 60" / 72"	12"	18"
	ADA Bench on 4 stainless steel posts with Back Support	42" / 48" / 60"	20" / 24"	Seat 18"
	Free Standing Bench with Upholstered Seat and Shoe Rack	36" / 42" / 48"	12"	14" / 18"
	Single Sided Bench with Hangers and Shoe Rack	36" / 48"	12"	Seat 18"
	Double Sided Bench with Hangers and Shoe Rack	36" / 48"	24"	Seat 18"

UPPER COMPARTMENT CONFIGURATIONS:

Open Cubby	Full-size Locker	Safe and Small Cubby
		

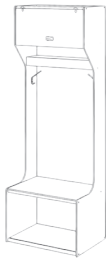
LOWER COMPARTMENT CONFIGURATIONS:

Open Cubby	Drawer	Chest with Lift-Up Seat
		

FOREMAN® STOCK COLORS



Maple



Amaretto Pine

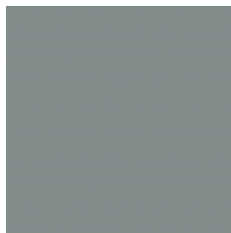

Medium Grey



Light Grey

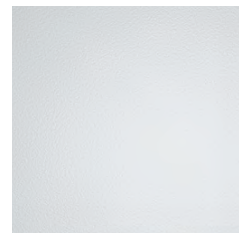

White





Foreman Locker Systems
41330 Date St., Murrieta,
CA 92562, United States

T: (951) 677-1955
E-mail: info@foremanlockers.com

foremanlockers.com