

15" Wide 15" Deep 71" High FOREMAN® Premium Phenolic 6-Tier Locker with Aluminum Extruded Profile

INTERIOR VIEW
WITHOUT DOOR

SIDE VIEW

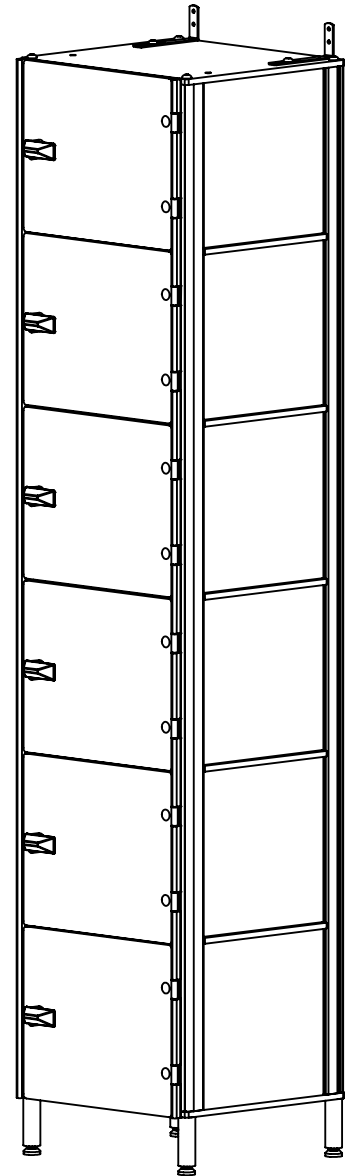
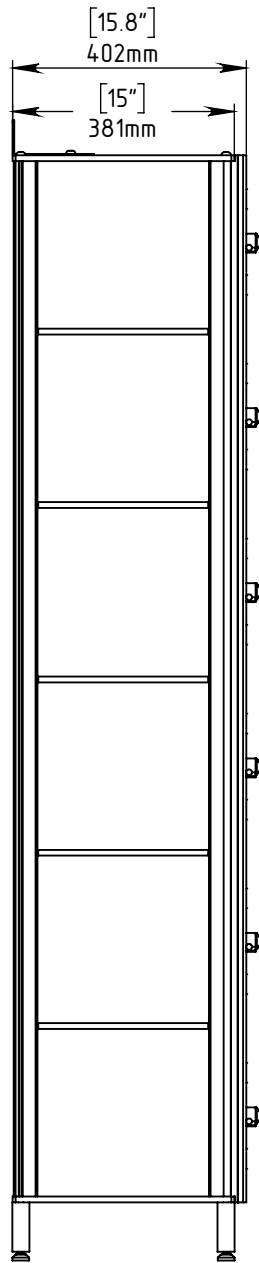
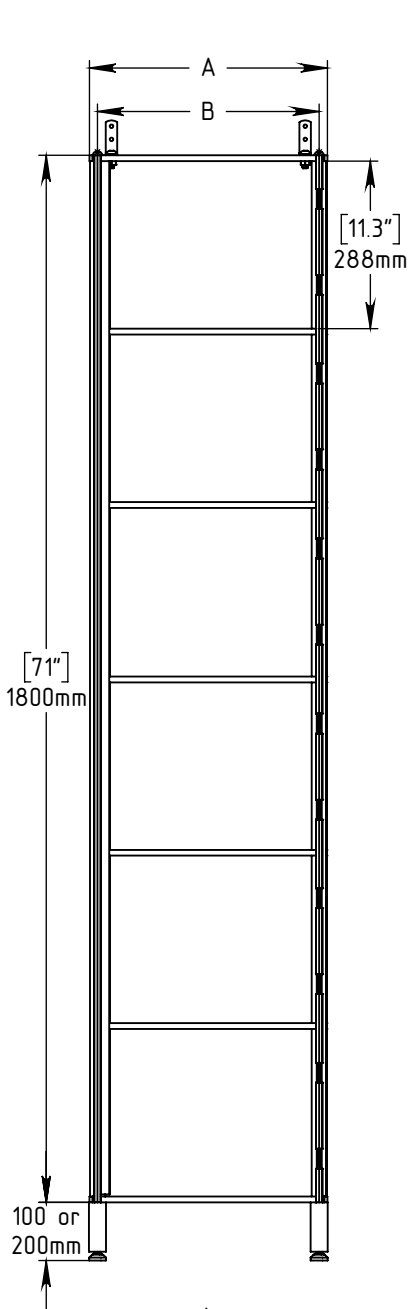

TOP VIEW

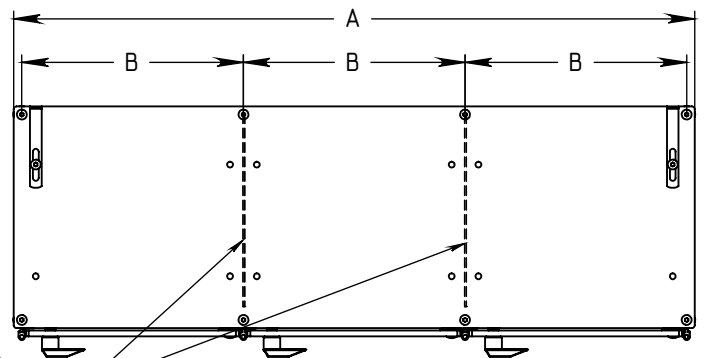
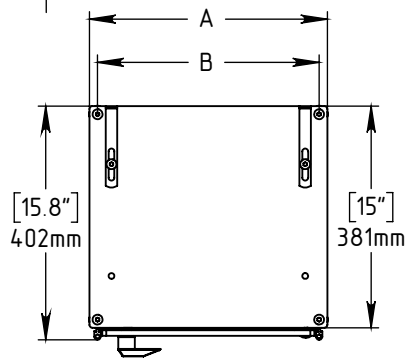

Any number of towers has shared common panels

	1 TOWER	2 TOWERS	3 TOWERS	4 TOWERS	5 TOWERS
WIDTH	B	A	A	A	A
	15"	16.1"	31.1"	46.1"	61.1"
	381mm	409mm	790mm	1171mm	1552mm

FOREMAN[®]
locker systems

PROPRIETARY AND CONFIDENTIAL

THE INFORMATION CONTAINED IN THIS DRAWING IS THE SOLE PROPERTY OF FOREMAN® PRODUCTS LLC. ANY REPRODUCTION IN PART OR AS A WHOLE WITHOUT THE WRITTEN PERMISSION OF FOREMAN® PRODUCTS LLC IS PROHIBITED.

DESCRIPTION	NAME	DATE
15"W 15"D 71"H 6-Tier Phenolic Locker with Aluminum Profile	KB	30.03.2019
SCALE: --	MRG APPR. NB	--
SHEET # 1		

FOREMAN Lockers' unique construction design of phenolic panels in aluminum profiles creates sectional, mutually integrated frames that eliminate the need for screws, dowels, glue or other permanent fastenings. Extremely strong, highly impact resistant, waterproof and non-corroding, the result is a completely modular system: less expensive to ship, simple to install, ideal for retrofit or remodel. The KD design allows them to be disassembled and reassembled without compromise to the material or structural integrity of the finished product.

SPECIFICATIONS

Panel Materials

All interior walls are constructed of 1/8 inch HPL phenolic panels. Floor, ceiling and shelves, as well as filler and finish end-panels are constructed of 3/8 inch HPL phenolic Compact™ Structural Laminates made by FUNDERMAX® (or equivalent).

Doors

Doors are constructed of 3/8 inch thick HPL phenolic material with polished, radius edges. Doors open 180 degrees for full compartment access. Ample ventilation is provided by a 3mm gap around the entire door perimeter.

Body

Extruded aircraft aluminum profiles are bolted to 3/8 inch thick phenolic top and bottom panels to create the box frame with 1/8 inch thick HPL phenolic panels for back and side walls creating a completely phenolic body.

Hinges

3.5 mm thick cast aluminum hinges are integrated directly into the extruded aluminum profiles and are continuous for the length of the locker body. Single compartment doors are secured to hinge on 4 door wings each with single zinc-plated through-bolt.

Strike Plate

4mm thick aluminum strike plate is integrated into the profile and is continuous for the entire length of the locker body providing additional security.

Interior Hooks

Single-Tier, Double-Tier and Z-Shape 71" or optional 80" High Lockers have a 3-pronged, rotating polished aluminum ceiling hook.

Number Plates

Adhesive mounted brushed aluminum plates with black etched reveal.

Color

Doors and exterior finish side panels are available in a variety of colors, patterns and wood grains from the FUNDERMAX® (or equivalent) color chain. Interior body panels are available in white (or optional black).

Finishes

Profiles are powder coated with a polyester-epoxy single coat with integral gloss finish. Gray color (standard) or custom colors optional. All frame fasteners are stainless steel.

OPTIONAL FEATURES

Locks

FOREMAN® Padlock cam-hasps are made of anodized heavy-duty cast aluminum and come as a standard feature.

The continuous strike plate accommodates virtually any mechanical or electronic locking mechanisms (cam, deadbolt, spring bolt) from a variety of manufacturers.

Shelving

Interior top/hat shelf with hanging 3 prong hook. Interior footwear shelf (for US-Type Z-Lockers, not needed for EU-Type Lockers).

Hanging clothes bar

The bar comes with HAFELA® sliding hooks.

Adjustable Legs

Extruded Aluminum, 4 or 8 inches, with up to 1 inch adjustability.

Doors

Extra thick 1/2" HPL material.

USB- and Power Outlet

Placed on the back panel or on the side mounted bracket of each compartment.